

1. Smart Blinds motor

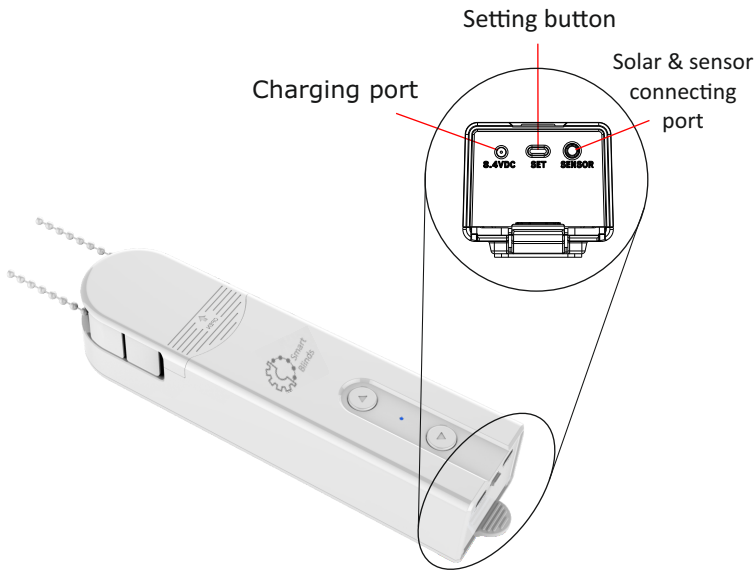

Manual Instruction

smart-blinds.eu

2. Specification

Model	SMB-101
Input power	8.4V DC
Solar panel	12V / 0.3W
Lock-rotor current	1.8A
Speed range	20-40 RPM
Torque	0.45 Nm
Rated current	1A
Battery	7.4V DC / 1000 mAh
Bluetooth pairing code	5555

CAUTION:

Do not operate the blind manually after the motor is installed.



When not in use, the motor should be recharged at least once every 6 months to maintain the battery life.

Do not expose the device to strong sun. Keep the device away from high temperatures and water during use and storage.



3. Motor Illustration

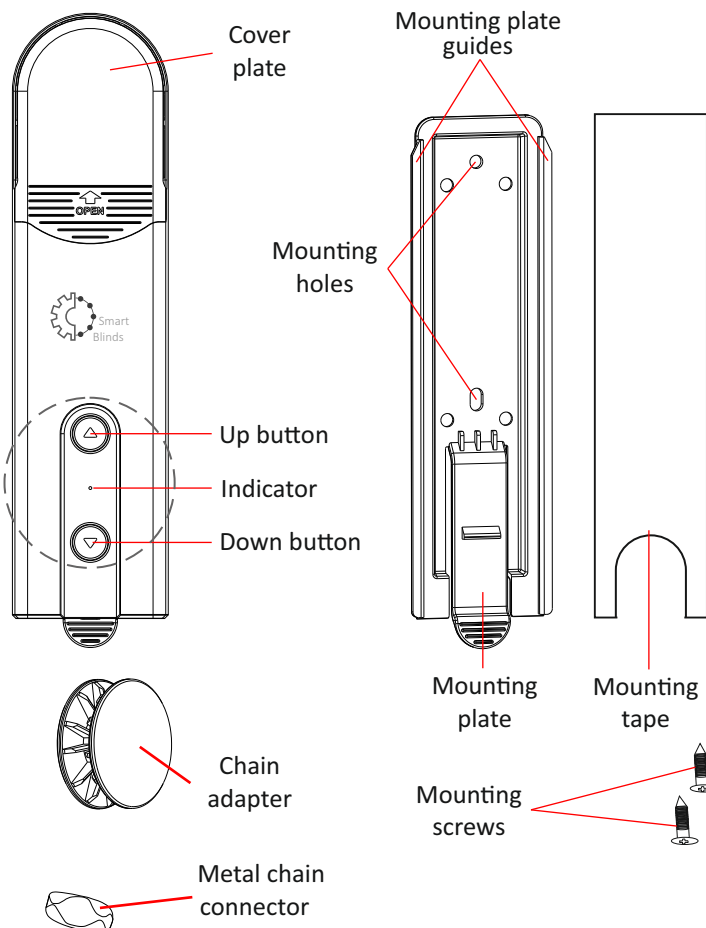

4. Functions and properties

- After switching off, the motor retains the last settings.
- Options and settings can be changed by applications on the phone connected via bluetooth.
- Large battery capacity for long work. (Battery level indicator available in the mobile application.)
- Charged via cable (or solar panel *).
- The light sensor built into the solar panel * allows for automatic setting of the opening/closing of the blind.

Solar panel

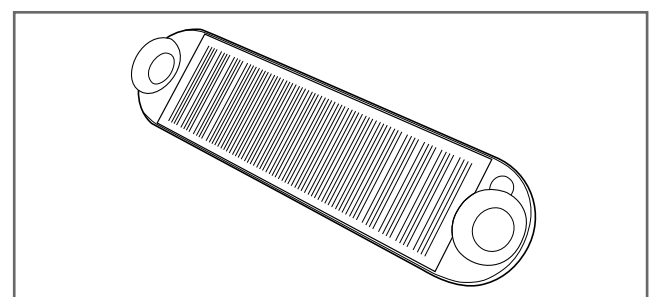

* Solar panel with light sensor available separately.

5. Installation

5.1 Replace chain connector

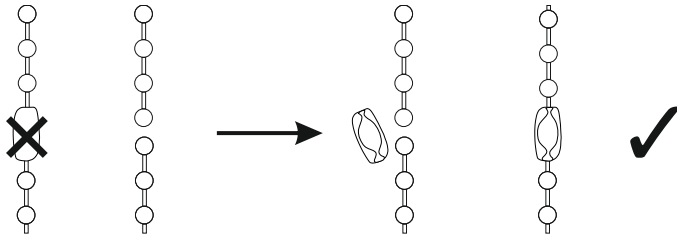

If the chain has a connector (s), all of them should be dismantled, and the connector connecting the ends of the chain should be replaced with a metal connector .

5.2 Remove cover plate.

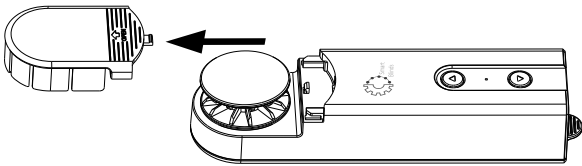

5.3 Methods of mounting.

5.3.1 Vertical mounting 5.3.2. Horizontal mounting**

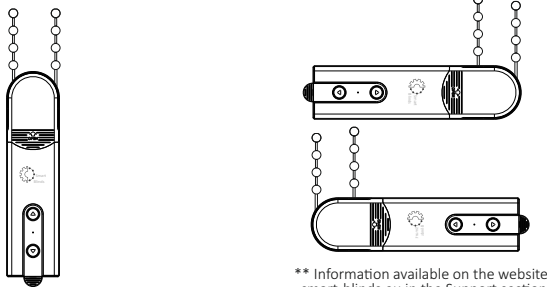

** Information available on the website smart-blinds.eu in the Support section.

5.4 For vertical mounting, break off the two plastics in the cover plate.

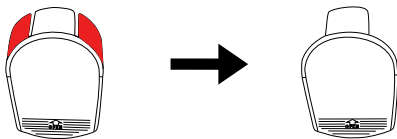

5.5. Marking the location for vertical mounting.



In the case of mounting to the window or to the wall above the sill, the distance between the motor and the sill must not be less than 4.5 cm.

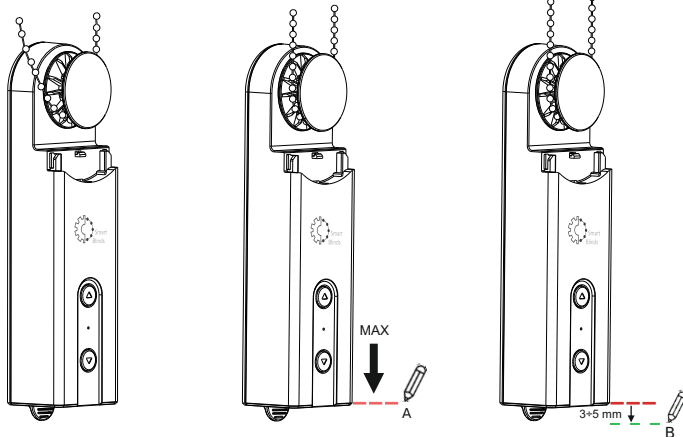

5.4.1. Put the chain on the adapter

5.4.2. Tighten the chain as far as it will go, marking position A.

5.4.3. Mark the place of mounting (pos. B) below the marked position A.

5.6. Attach the motor to the surface.

In the case of blinds on the framemount Smart blinds on the same window frame. In the case of blinds mounted on the wall/ceiling mount the motor on the wall.

5.6.1. Using mounting tape



Before installing on the window sash, degrease the window frame and the surface of the mounting plate with a cleaning tissue.
* Cleaning tissue available separately

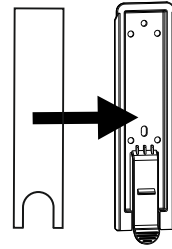

Slide out the mounting plate and then stick the attached mounting tape to it.

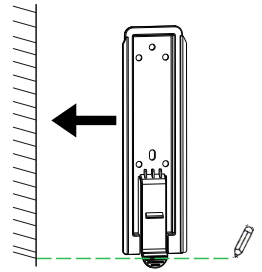

Glue the mounting plate according to the marked position B.

5.6.2. Using the mounting screws

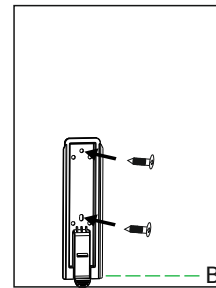

Attach the mounting plate to the surface using screws.

5.7. Slide the motor onto the mounted plate.

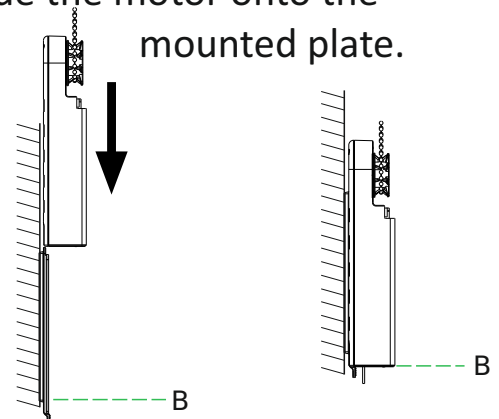

5.6.1. Place the motor in the guides on the mounting plate.

5.6.2. Slide the motor towards the plate until the chain tension is in position B.

5.8. Put the adapter cover on.

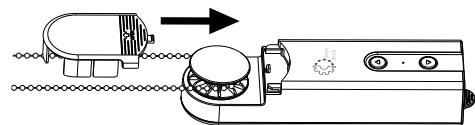

5.9. Attach the solar panel* to the window and connect it to the motor.

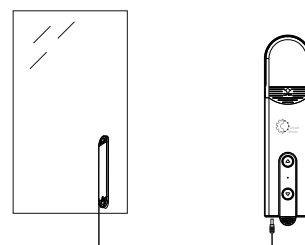

* Solar panel with light sensor available separately.

6. Settings via the app.

The Smart Blinds motor can be operated using an application that allows you to control: closing and opening the roller blinds and setting the upper and lower position.

The applications are available in the Google Play and AppStore stores.
(search for "smart blinds" or scan the QR code available at the end of the manual)

6.1. Download

Google Play



Apple App Store

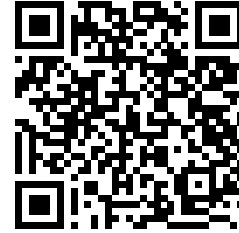

7. Manual settings

7.1. Upper limit setting

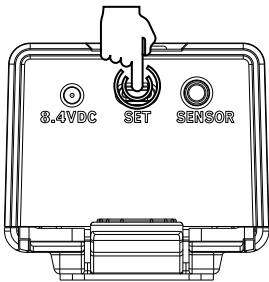

Press and hold the setting button for 3 seconds.

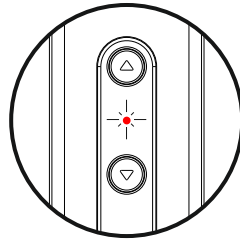

The indicator light will turn on on red (motor is in settings management state).

7.2. Bottom limit setting

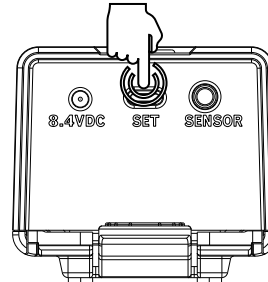

Press and hold the setting button for 3 seconds.

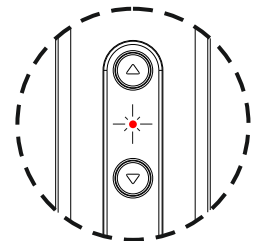

The indicator light will turn on on red (motor is in settings management state).

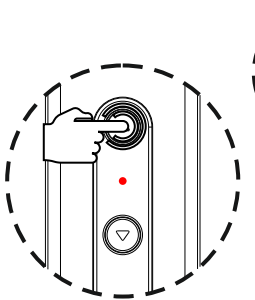

Press the "Up" button

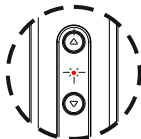

The LED will flash red.

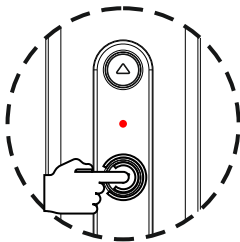

Set the blind to the target position.

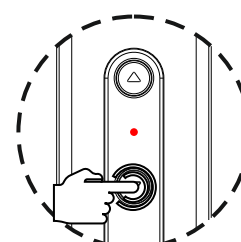

Press the "Down" button

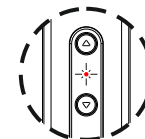

The LED will flash red.

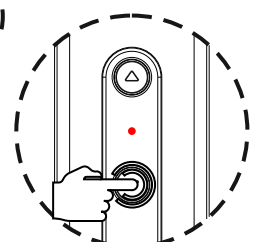

The bottom limit has been set.

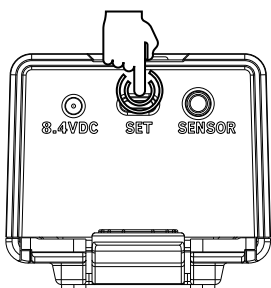

Press and hold the setting button for 3 seconds.

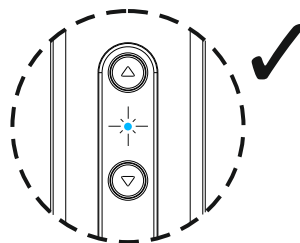

The indicator light turns on blue 3 times. Upper limit setting has been set.

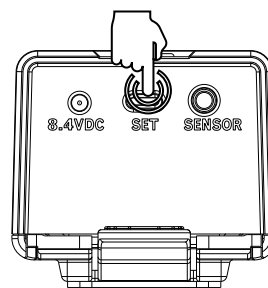

Press and hold the setting button for 3 seconds.

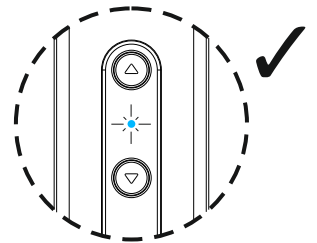

The indicator light turns on blue 3 times. Bottom limit setting has been set.

7. Manual settings

7.3 Turning on

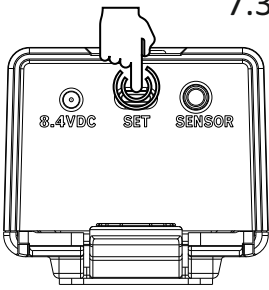

Hold down the settings button for 1 second.

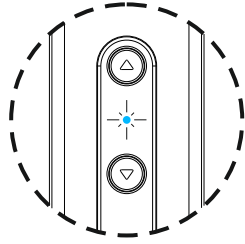

The indicator light will flash blue for 2 seconds (device is turned on).

7.6. Change of direction of movement

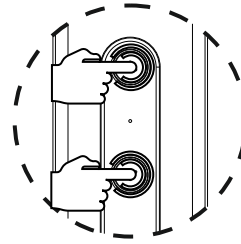

Press and hold both buttons simultaneously for 3 seconds.

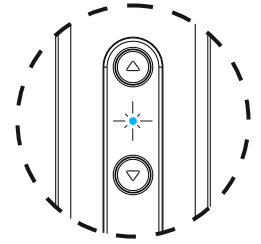

The indicator light will turn on blue 3 times (direction has been changed).

7.4 Shutting down

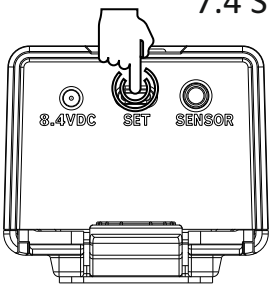

Hold down the settings button for 7 seconds.

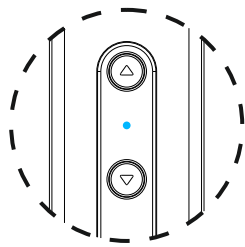

The indicator light will flash blue 3 times (the device is turned off).

7.7. Changing the direction setting of the motor

(The default mode is step mode. Please follow the instructions to change it.)

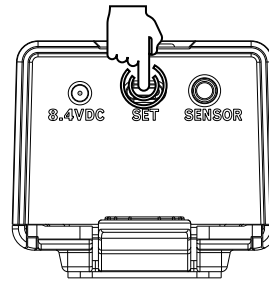

Press the settings button 5 times.

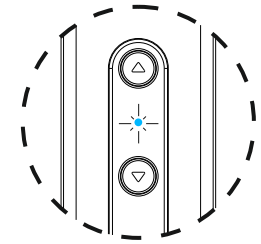

The indicator light will flash on blue (mode has been changed).

7.5. Restore default settings

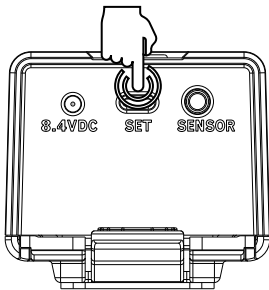

Press and hold the setting button for 3 seconds.

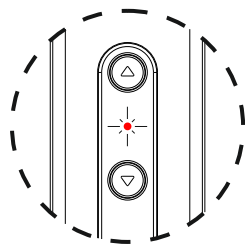

The indicator light will turn on on red (motor is in settings management state).

7.8. Continuous mode

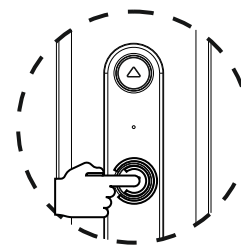

Press the selected button. The motor will start rotating.

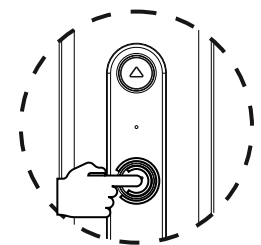

Press the button again. The motor will stop.

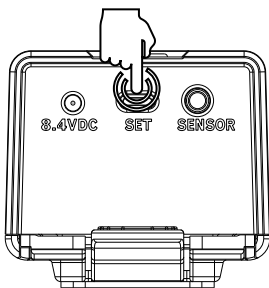

Press and hold the setting button for 7 seconds.

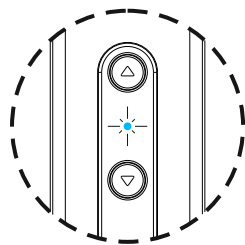

"The indicator light will turn on blue 3 times (settings reset, device is in factory default state).

7.9. Step mode

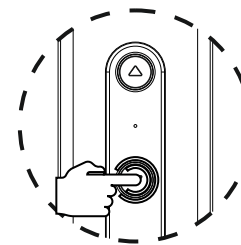

Press and hold any button for less than 1.5 seconds. The motor will stop rotating after releasing the button.

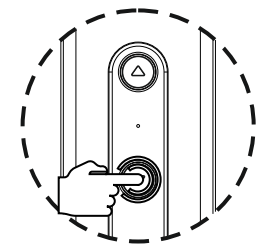

Press and hold the selected button for more than 1.5 seconds. The motor will stop turning at next button press.